

EXPLODED DRAWING A

Model No. NTEVEL69818.0 R0818A

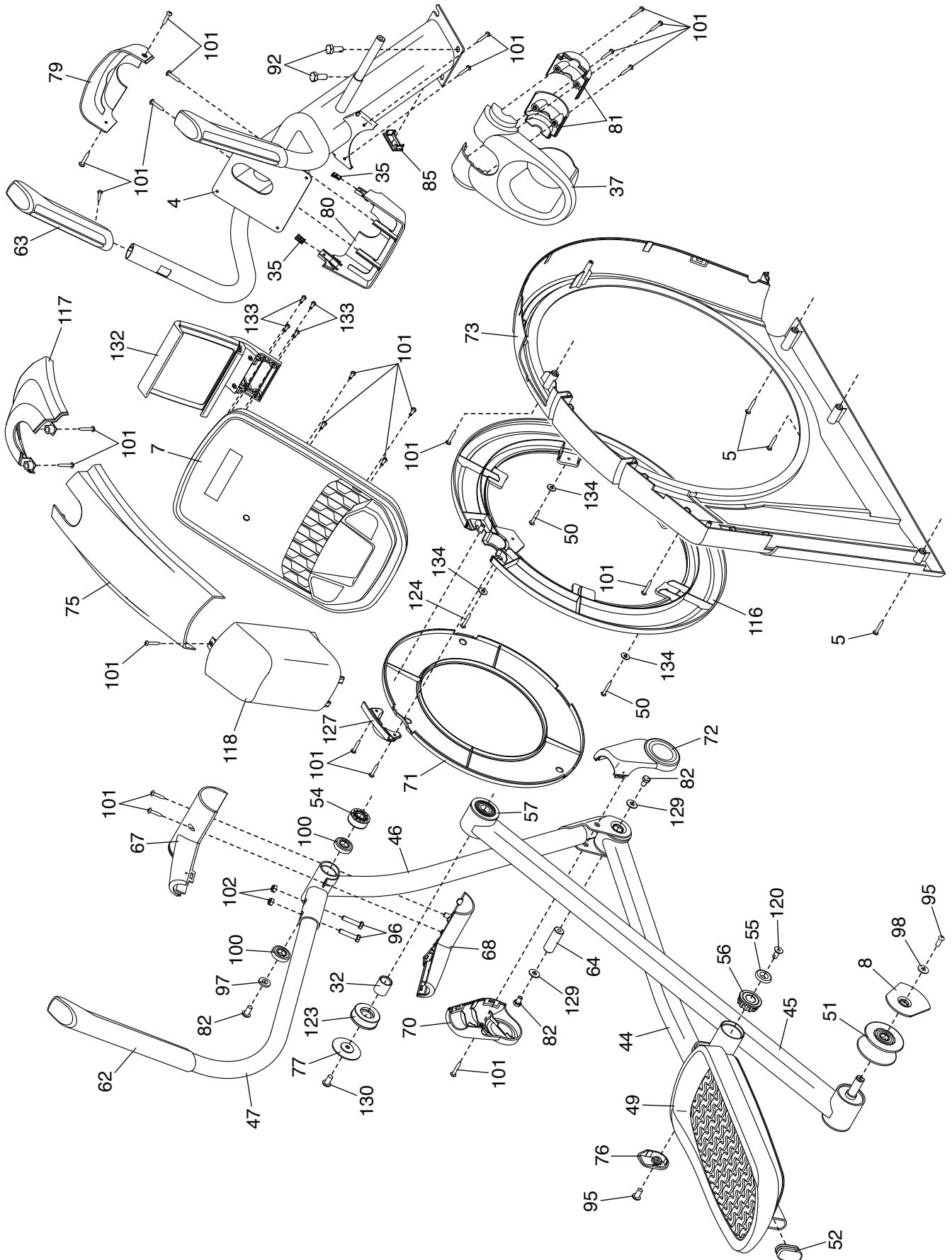

EXPLODED DRAWING B

Model No. NTEVEL69818.0 R0818A

